

# 4/3, 4/2 and 3/2 explosion-proof solenoid directional valve

Type WE6...61B/

Size (NG) 6  
Up to 350 bar  
Up to 80 L/min

## Contents

Function and configuration	02
Ordering code	03
Spool symbols	03
Technical data	04
Electrical data	04
Characteristic curves	05
Performance limits	05
Unit dimensions	06

## Features

- Directly operated type explosion protection directional valve is used as the standard type
- DIN24 340 A type on the mounting surface
- ISO 4401
- Wet-type DC explosion protection solenoid
- 90° rotatable explosion protection solenoid
- Pressure-tight chamber does not need to be opened when coil is to be replaced

## Function and configuration

WE type directional control valve is the directional valve of explosion protection solenoid used to control start, stop and flow direction of oil fluid.

The directional control valves consist of housing (1), one or two solenoids (2), the control spool (3), and one or two return springs (4).

In the de-energised condition the control spool (3) is held in the neutral or initial position by means of return springs (4) (except for pulse spools). The control spool (3) is actuated via wet pin solenoids (2).

To guarantee satisfactory operation care should be taken to ensure that the solenoid pressure chamber is filled with oil.

The control spool (3) is moved to the expected position by solenoid (2) and pushing rod (5), and this gives free flow from P to A and B to T or P to B and A to T.

When the explosion protection solenoid (2) is powered off, control valve element (3) is pushed to the initial position by reset spring (4).

### Type 4WE6...61B/O...

(limited to functions A, C and D).

This type contains 2 switching positions and 2 directional control valves without locating mechanism explosion protection solenoid.

### Type 4WE6...61B/OF... pulse valve

(limited to functions A, C and D).

It contains 2 switching positions, 2 explosion protection solenoids and 1 directional control valve with locating mechanism. 2 switching positions are fixed separately, so it is unnecessary to continuously electrify explosion protection solenoid.

### Cartridge throttle

The cartridge throttle is necessary since the actual flow may be larger than the performance limits of the valve during switching process. This cartridge throttle is inserted in the P channel of the directional control valve.

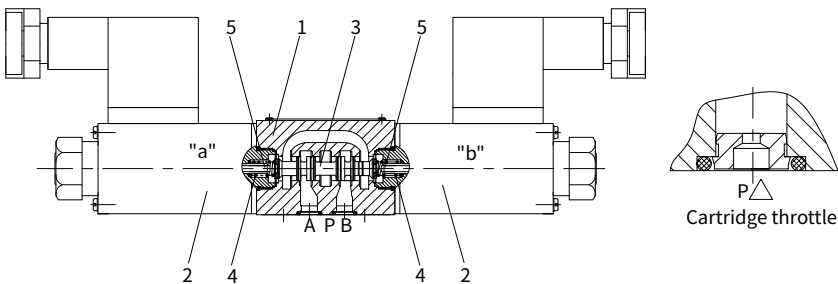

# Ordering code

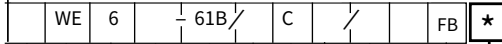

Other requirements

3 ways (For spool A, B) = 3  
4 ways = 4

Directional valve with wet pin solenoids

Nominal size 6 = 6

Symbols e.g. C, E etc.

Serial number = 61  
(60-69 have the same interior structures and mounting dimensions)

Return spring = No code  
Without return spring = O  
Without return spring, and with detent = OF

Threaded explosion protection solenoid = C

V = NBR seals  
FKM seals

NO code without Throttle  
B08 = Throttle  $\Phi$ 0.8mm  
B10 = Throttle  $\Phi$ 1.0mm  
B15 = Throttle  $\Phi$ 1.5mm  
B20 = Throttle  $\Phi$ 2.0mm  
B25 = Throttle  $\Phi$ 2.5mm  
B30 = Throttle  $\Phi$ 3.0mm

Voltage  
G12 = 12VDC  
G24 = 24VDC  
G36 = 36VDC  
G110 = 110VDC

**Note:** F B Explosion protection grade EX d I Mb; F B 2 Explosion protection grade EX d II C T4 Gb

## Spool symbols

Transition position Spool valve symbols

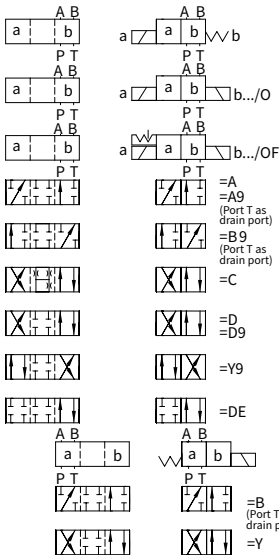

Transition position Spool valve symbols

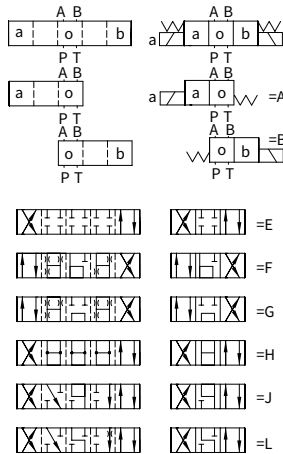

Example:  
If solenoid is fixed at position 'a', the ordering code is...EA.

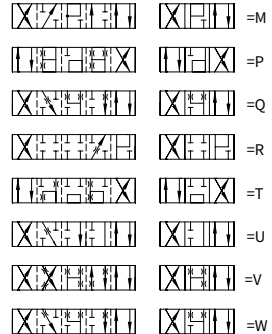

Notes:

no A9, B9, D9 and Y9.../O and.../OF...type  
A9, B9, D9 and Y9 are used as pilot valve only

## Technical data

Fixing position		Optional
Environment temperature range		°C
		-30 to +50 (NBR seal) -20 to +50 (FKM seal)
Weight	Single solenoid	kg
	Double solenoids	kg
		2.6 4.3
Max. operating pressure	Port P, A, B	bar
	Port T	bar
		350 210 when the operating pressure exceeds the permission value, spool symbol A and B must make the port T for draining
Max. flow-rate		L/min
		80
Flow cross section (switching neutral position)	VersionQ	mm <sup>2</sup>
	VersionW	mm <sup>2</sup>
		About 6% of nominal area About 3% of nominal area
Fluid		Mineral oil suitable for NBR and FKM seal Phosphate ester for FKM seal
Fluid temperature range		°C
		-30 to +80 (NBR seal) -20 to +80 (FKM seal)
Viscosity range		mm <sup>2</sup> /s
		2.8 to 500
Degree of contamination		Maximum permissible degree of fluid contamination: Class 9. NAS 1638 or 20/18/15, ISO4406

## Electrical data

Type of voltage		DC
Available voltage		V
		12, 24, 36, 110
Permissible voltage (deviation)		%
		-15 to +10
Input power		W
		30
Operation mode of solenoid		Continuous working
Switched time	ON	ms
	OFF	ms
Accord with ISO 6403		25 to 45 10 to 25
Switched frequency		times/h
		To 15000
Max. coils temperature		°C
		+150

**Caution:** with electrical connections the protective conductor (PE  $\perp$ ) must be connected according to the relevant regulations.

## Characteristic curves

(Measured at  $\vartheta_{oil}=40^{\circ}\text{C} \pm 5^{\circ}\text{C}$ , using HLP46)

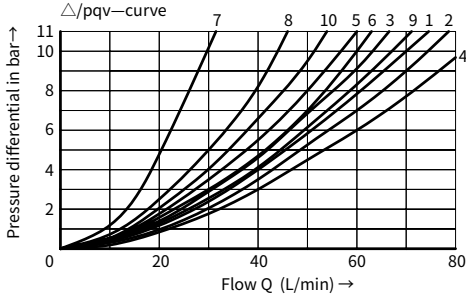

- 7 Function "R" of valve element is at switching position B → A  
 8 Function "G" and "T" of valve element is at neutral position P → T  
 9 Function "H" of valve element is at neutral position P → T

Spool symbol	Flow direction			
	P → A	P → B	A → T	B → T
AB	3	3	-	-
C	1	1	3	1
DY	5	5	3	3
E	3	3	1	1
F	1	3	1	1
T	10	10	9	9
H	2	4	2	2
JQ	1	1	2	1
L	3	3	4	9
M	2	4	3	3
P	3	1	1	1
R	5	5	4	-
V	1	2	1	1
W	1	1	2	2
U	3	3	9	4
G	6	6	9	9

## Performance limits

(Measured at  $\vartheta_{oil}=40^{\circ}\text{C} \pm 5^{\circ}\text{C}$ , using HLP46)

The Performance limited is measured when the solenoids under working temperature, the voltage is below 15% of the standard voltage and T is free from back pressure.

The working limit given is used for flow in two directions only (such as P → A flow of B → T backflow).

Due to the flow forces acting within the valves, the permissible switching power limits may be considerably lower with only one direction of flow (e.g. P → A while port B is blocked)

(In such cases, please consult us!)

The switching power limit was established while the solenoids were at operating temperature, at 10 % under voltage and without tank pre-loading.

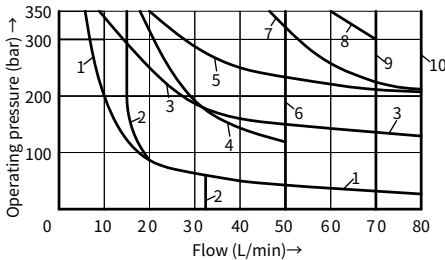

Curve	Spool symbol
1	A, B <sub>1</sub>
2	V
3	A, B
4	F, P
5	J
6	G, H, T
7	A/O, A/OF, L, U
8	C, D, Y
9	M
10	E, R <sub>2</sub> , C/O, C/OF D/O, D/OF, Q, W

Note: 1) Flow back to the fuel tank from the executive component

## Unit dimensions

(Dimensions in mm)

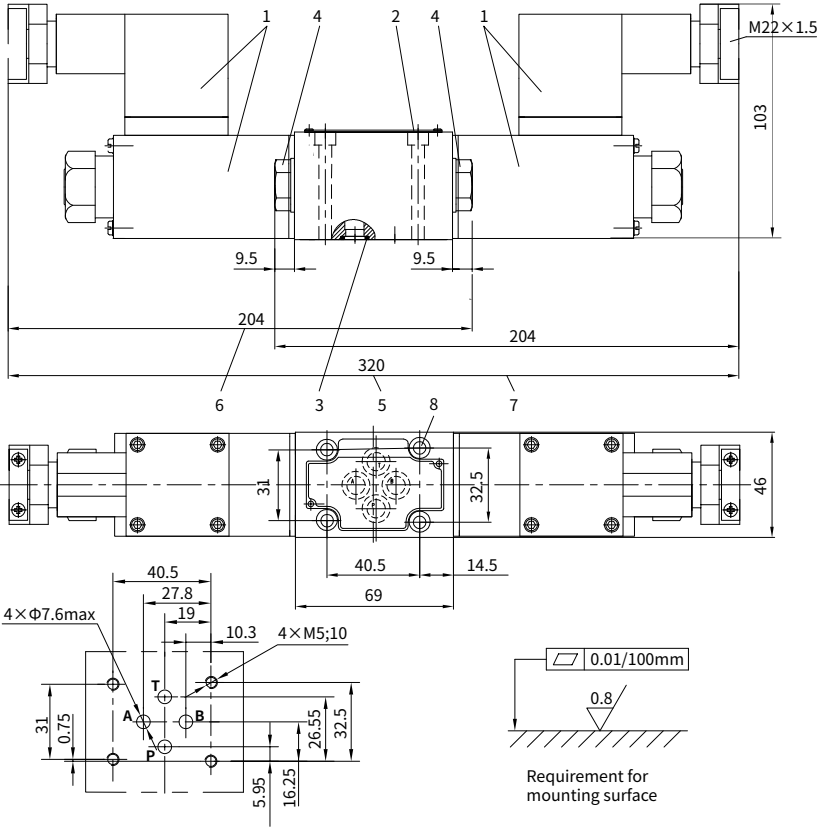

- 1 Explosion protection solenoid
- 2 nameplate
- 3 R-ring 9.81 × 1.5 × 1.78 or O-ring 9.25 × 1.78
- 4 End cap used for 1 electrosolenoid valve
- 5 Dimensions of 3-position valve
- 6 Dimensions of 2-position valve, solenoids at end A
- 7 Dimensions of 2-position valve, solenoids at end B

### 8 Valve fixing screws:

M5 × 50 GB/T70.1-10.9

Tightening torque,  $M_A=8.9\text{Nm}$   
must be ordered separately.

### It must be ordered separately, if connection plate is needed .Type:

G341/01(G1/4); G341/02(M14 × 1.5)

G342/01(G3/8); G342/02(M18 × 1.5)

G502/01(G1/2); G502/02(M22 × 1.5)